







Caratteristiche - Specifications

Materiale - Material	Alluminio - Aluminum
Peso al metro - Weight per meter	431 g
Lunghezza - Length	Su misura - Custom made
Grado protezione - IP rating	IP20
Finitura standard verniciata - Standard painted finish	
Finiture RAL (su richiesta) - RAL finishes (on request)	
Finiture metalliche - Metallic finishes	
Marche - Marking	

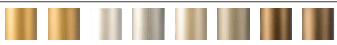
Caratteristiche Elettriche - Electrical specifications

Gruppo di alimentazione - Power supply unit	Remoto/ Remote
Tensione di alimentazione - Supply voltage	24 Vdc
Potenza totale - Total power	30 W/m
Classe di isolamento - Insulation class	
Dimmerazioni disponibili - Dimming available	Casambi - Dali - Push - 1-10 V

Sorgente luminosa - Light source

Tipo di sorgente - Type of source	LED		
Temperatura colore - Color temperature	2700 K	3000 K	4000 K
Flusso nominale LED - Nominal LED flux	4868 lm/m	4942 lm/m	5040 lm/m
Classe efficienza energetica LED - Efficiency class LED	D		
Durata - Duration life	L80/ B10 (25 °C) > 50.000 h		

Apparecchio - Device

Temperatura colore - Color temperature	2700 K¹	3000 K²	4000 K³
Flusso lampada - Light flux	3599 lm/m	3654 lm/m	3726 lm/m
Efficienza lampada LED - LED lamp efficiency	120 lm/W	122 lm/W	124 lm/W
Indice rosso saturo - Saturated red colour index (R9)	>60	>70	>80
Indice di resa cromatica - Colour rendering index (Ra)	95		
SDCM	3		
Rischio fotobiologico - Photobiological risk	RG 0		

Caratteristiche sistema ottico - Optical system characteristics

Materiale dell'ottica - Material lens	Policarbonato - Polycarbonate
---------------------------------------	--------------------------------------

Codice prodotto - Product Code

¹ 30&60_56L_UU_WW2_9

² 30&60_56L_UU_WW9

³ 30&60_56L_UU_NW9

. z= B (black), W (white), ? (special/on request)

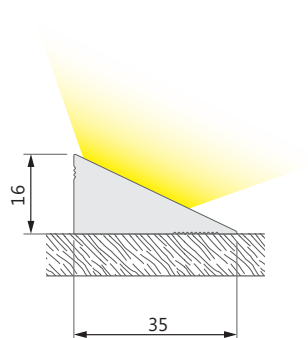

In appoggio
In support

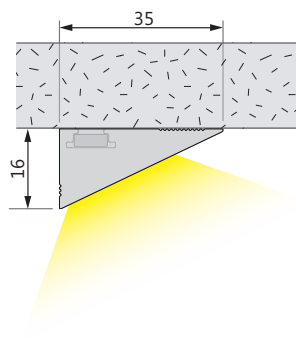

Fissaggio magnetico
Magnetic fastening

DATI FOTOMETRICI - PHOTOMETRIC DATA

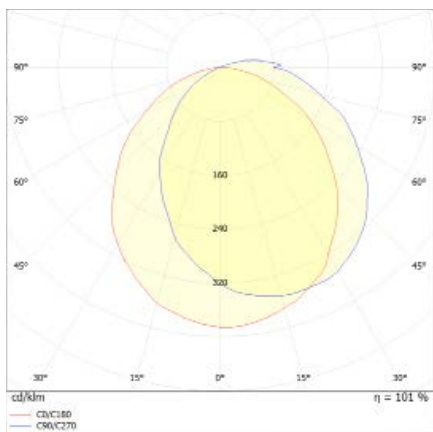

Ottica 120°

FINITURE VERNICIATE - PAINTED FINISHES

FINITURE SPECIALI - SPECIAL FINISHES



"BRONZE"

"BRUSHED BRONZE"

"CHAMPAGNE"

"BRUSHED CHAMPAGNE"

"GOLD"

"BRUSHED GOLD"

FINITURE SPECIALI RAL (su richiesta) - SPECIAL FINISHES RAL (on request)

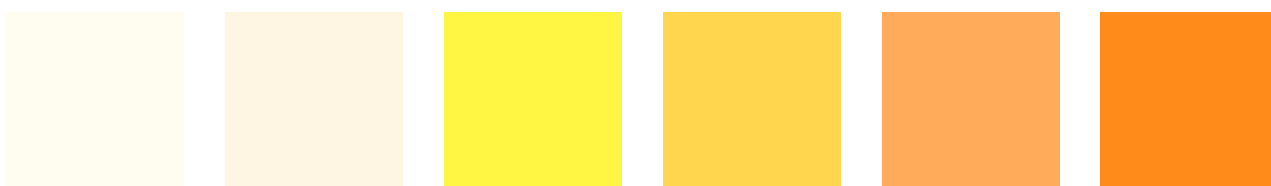

RAL9001

RAL1013

RAL1016

RAL1018

RAL1017

RAL1028



RAL2000

RAL3022

RAL2002

RAL3020

RAL3003

RAL3015

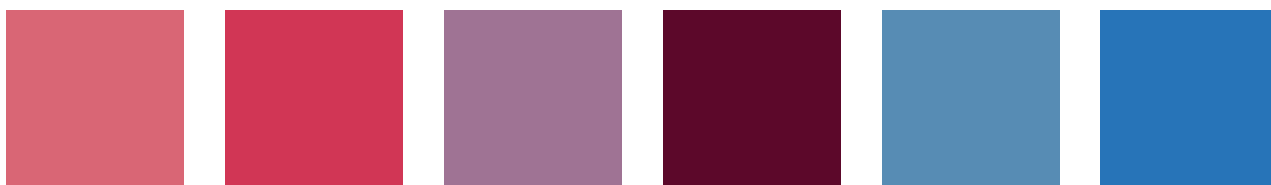

RAL3014

RAL3017

RAL4009

RAL4004

RAL5024

RAL5012



RAL5014

RAL5019

RAL5000

RAL6021

RAL6018

RAL6029



RAL5021

RAL7000

RAL7015

RAL7035

RAL7036

RAL ON REQUEST